

50 Ω nominal input / conjugate match balun to BlueNRG transceiver, with integrated harmonic filter

Datasheet — production data

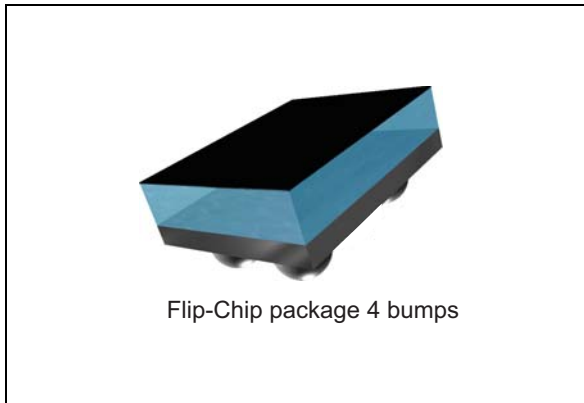

Description

STMicroelectronics BALF-NRG-01D3 is an ultra miniature balun. The BALF-NRG-01D3 integrates matching network and harmonics filter. Matching impedance has been customized for the BlueNRG ST transceiver (both QFN and WLCSP versions). It is using STMicroelectronics IPD technology on non conductive glass substrate which optimizes RF performance.

Features

- 50 Ω nominal input / conjugate match to BlueNRG device
- Low insertion loss
- Low amplitude imbalance
- Low phase imbalance
- Wafer level chip scale package (WLCSP)

Benefits

- Very low profile: < 670 μm
- High RF performance
- RF BOM reduction
- Small footprint

Applications

- Bluetooth low energy impedance matched balun filter
- Optimized for ST BlueNRG RFIC

Figure 1. Application schematic with QFN type BlueNRG

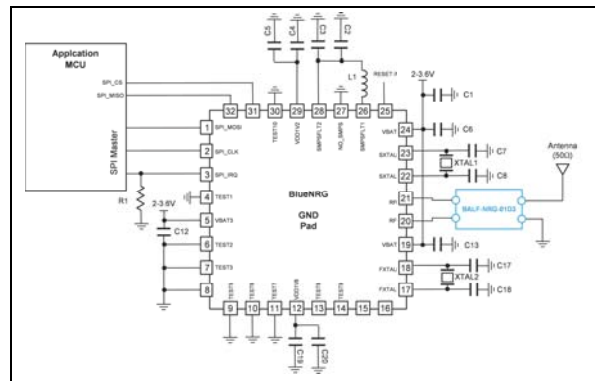
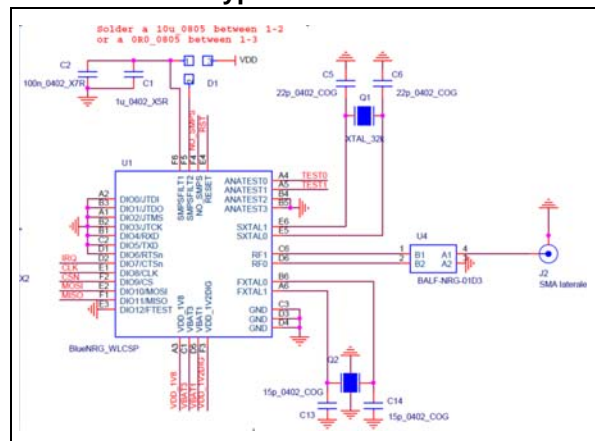

Figure 2. Application schematic with WLCSP type BlueNRG



1 Characteristics

Table 1. Absolute maximum ratings (limiting values)

Symbol	Parameter	Value			Unit
		Min.	Typ.	Max.	
P_{IN}	Input Power RFIN		-	10	dBm
V_{ESD}	ESD ratings human body model (JESD22-A114-C), all I/O one at a time while others connected to GND	2000	-		V
	ESD ratings machine model (MM: C = 200 pF, R = 25 Ω , L = 500 nH)	200	-		
T_{OP}	Operating temperature	-40	-	+105	$^{\circ}\text{C}$

Table 2. Impedances ($T_{amb} = 25^{\circ}\text{C}$)

Symbol	Parameter	Value			Unit
		Min.	Typ.	Max.	
Z_{diff}	Nominal differential impedance	-	Match to BlueNRG	-	Ω
Z_{ANT}	Antenna impedance	-	50	-	Ω

Table 3. RF performance ($T_{amb} = 25^{\circ}\text{C}$)

Symbol	Parameter	Test condition	Value			Unit
			Min.	Typ.	Max.	
f	Frequency range (bandwidth)		2400		2500	MHz
S11	Input return loss bandwidth			-20		dB
S21	Insertion loss			-1.1		dB
S21	Harmonic rejection (differential mode)	H2		-8		dB
		H3		-38		
		H4		-31		
		H5		-23		
Phase_imbal	Output phase imbalance			7		$^{\circ}$
Ampl_imbal	Output amplitude imbalance			0.5		dB

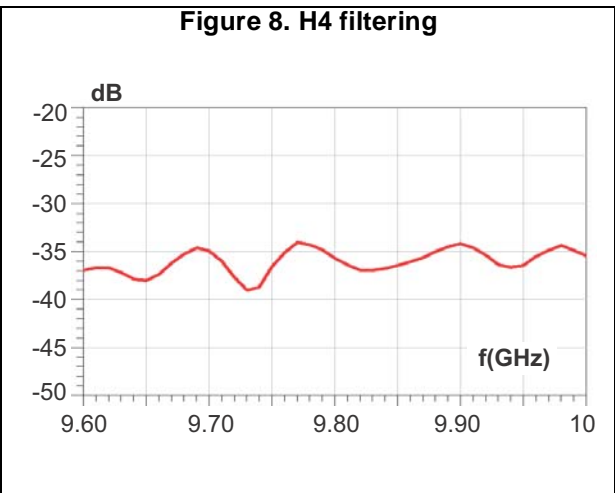
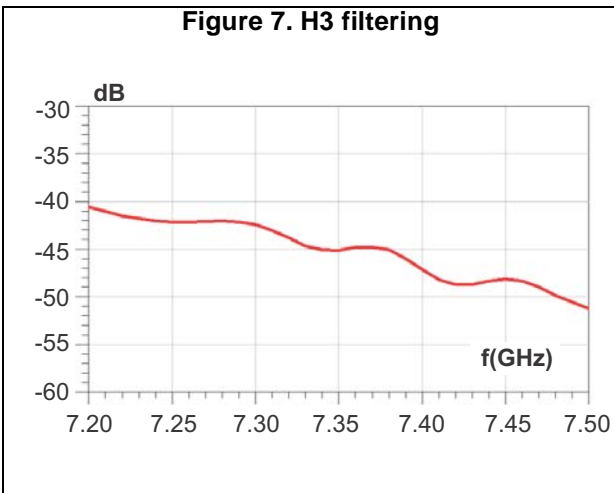
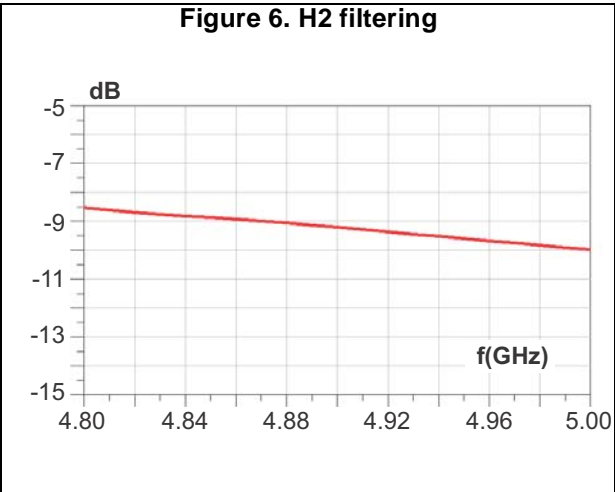
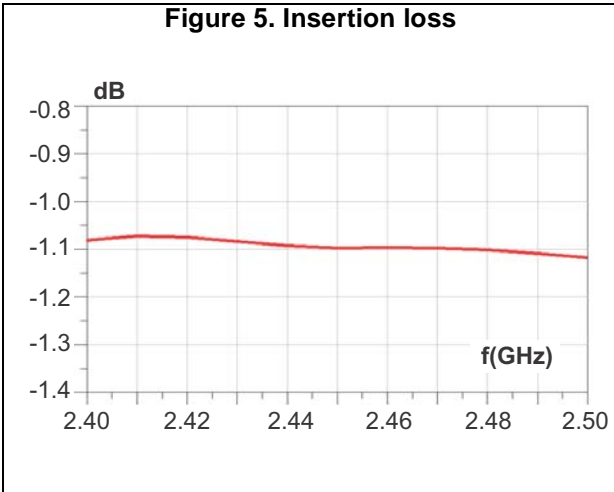
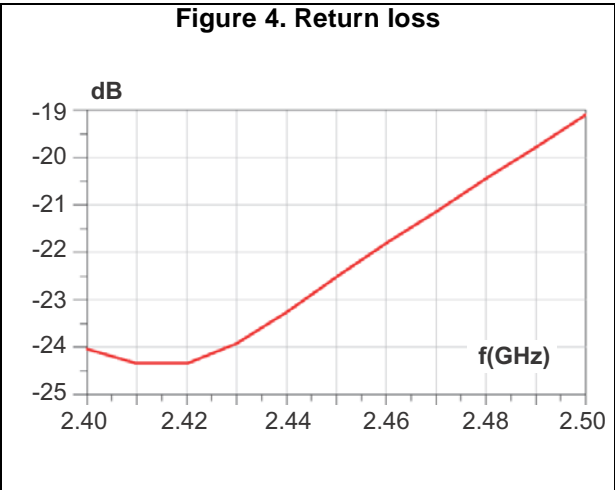
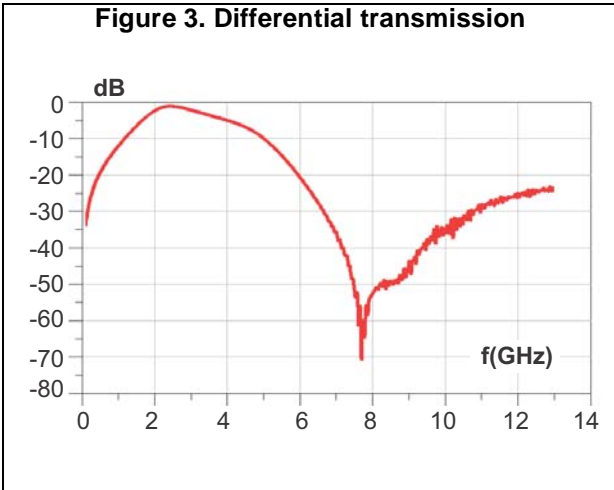

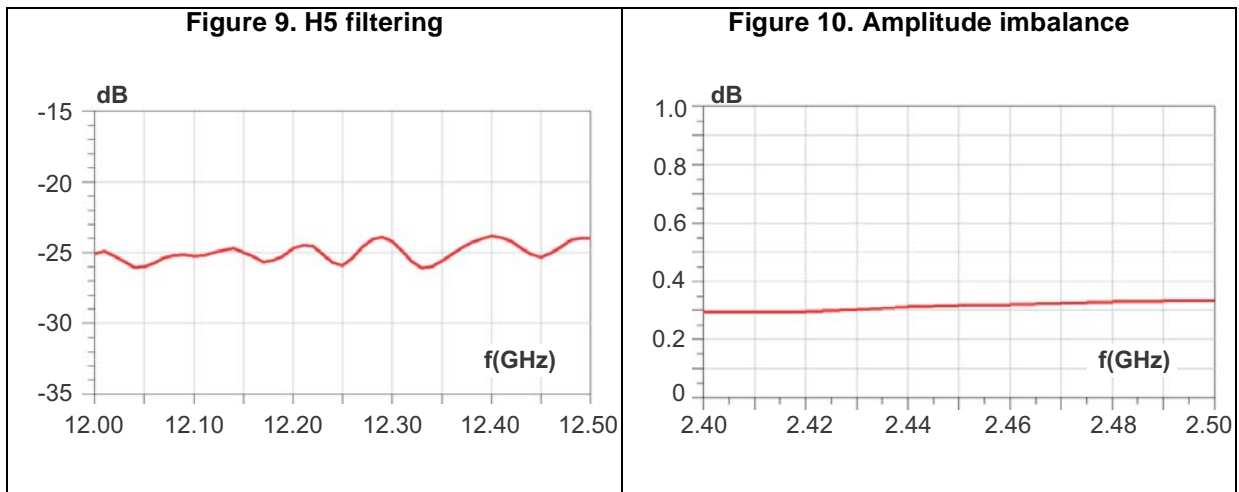
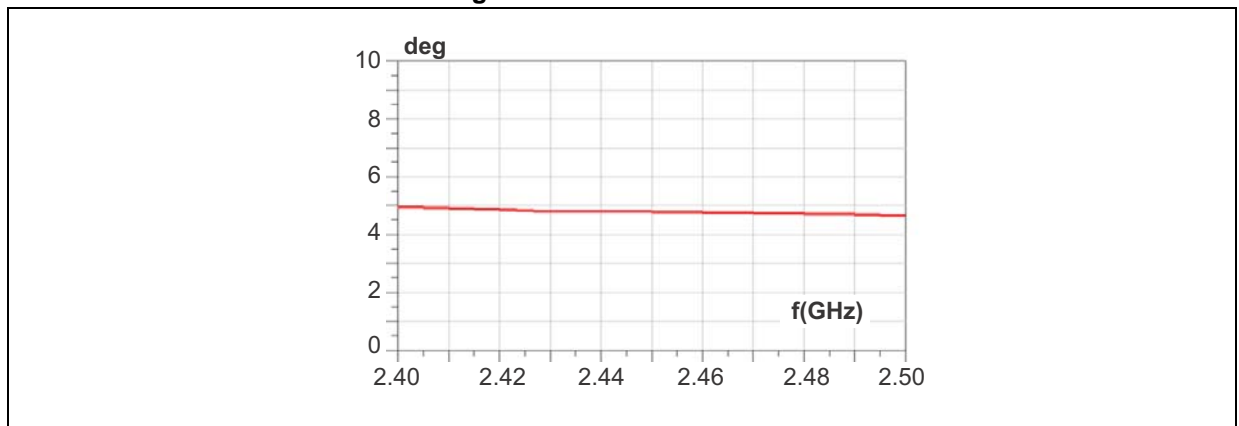

Figure 11. Phase imbalance



2 BALF-NRG-01D3 with QFN type BlueNRG

Figure 12. Application board EVB (2 layers)

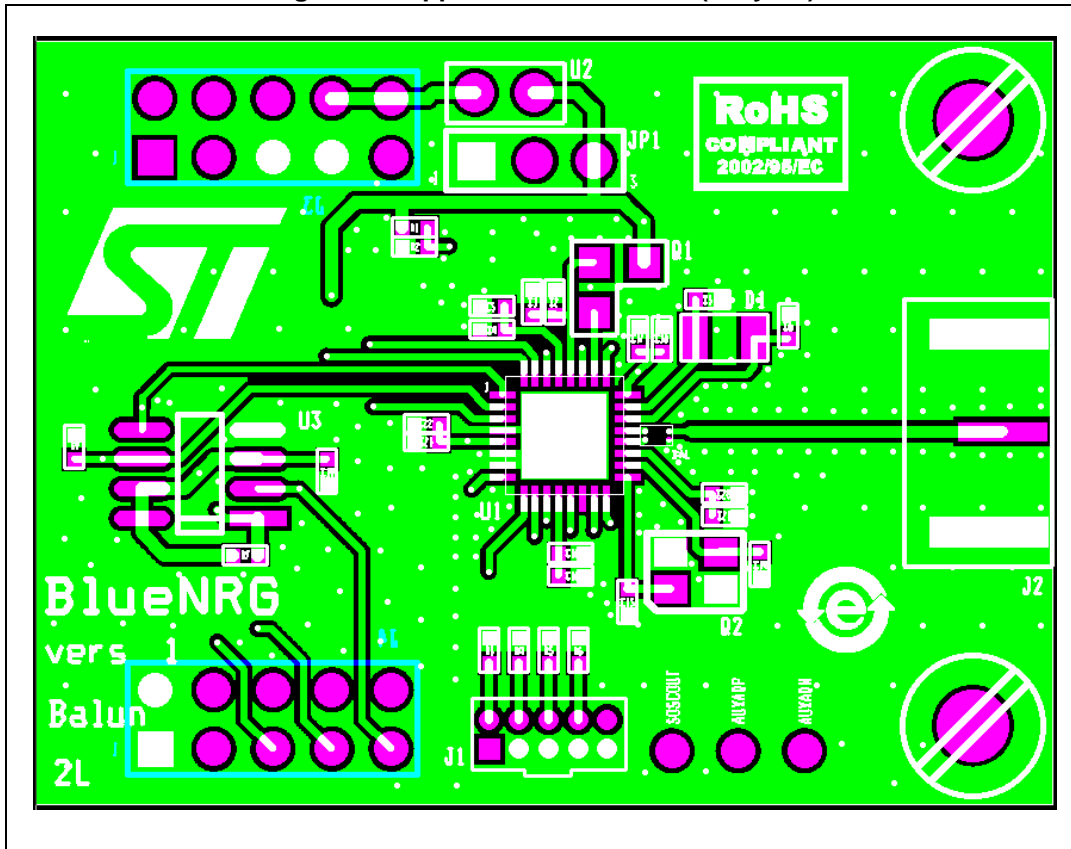
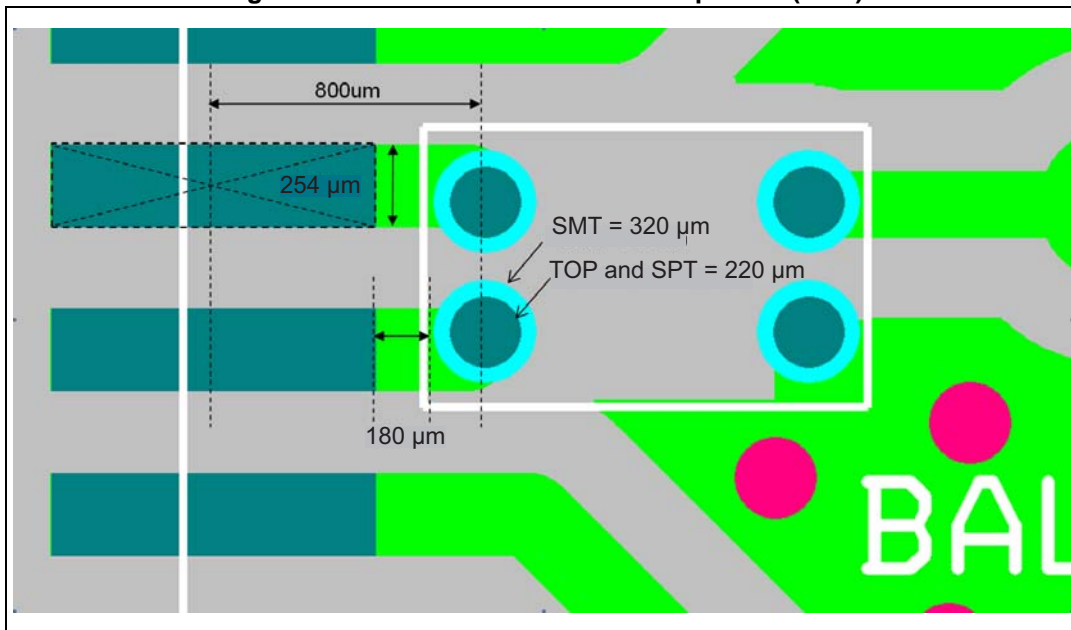

Figure 13. Recommended balun land pattern (EVB)



2.1 BALF-NRG-01D3 measurements on QFN EVB

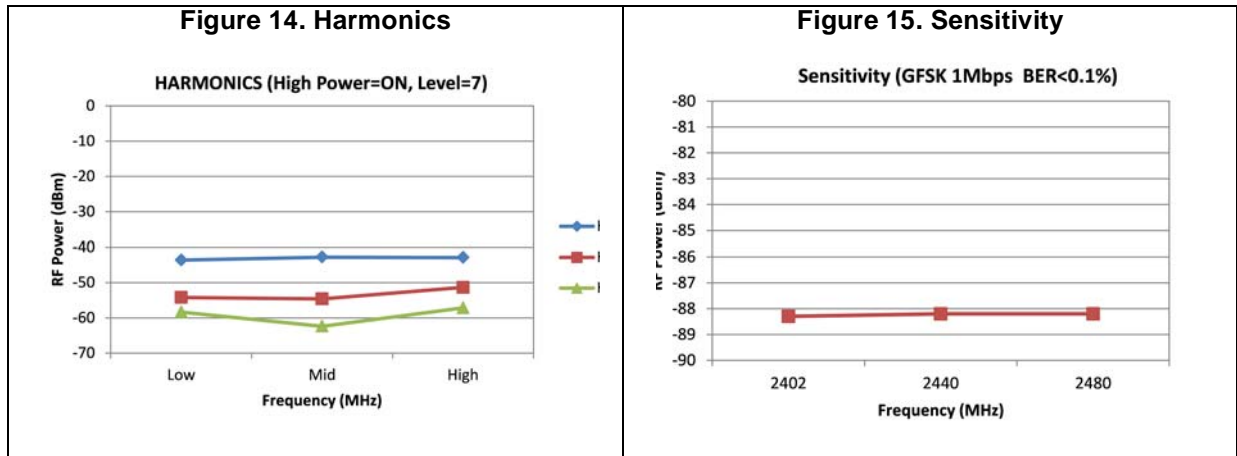
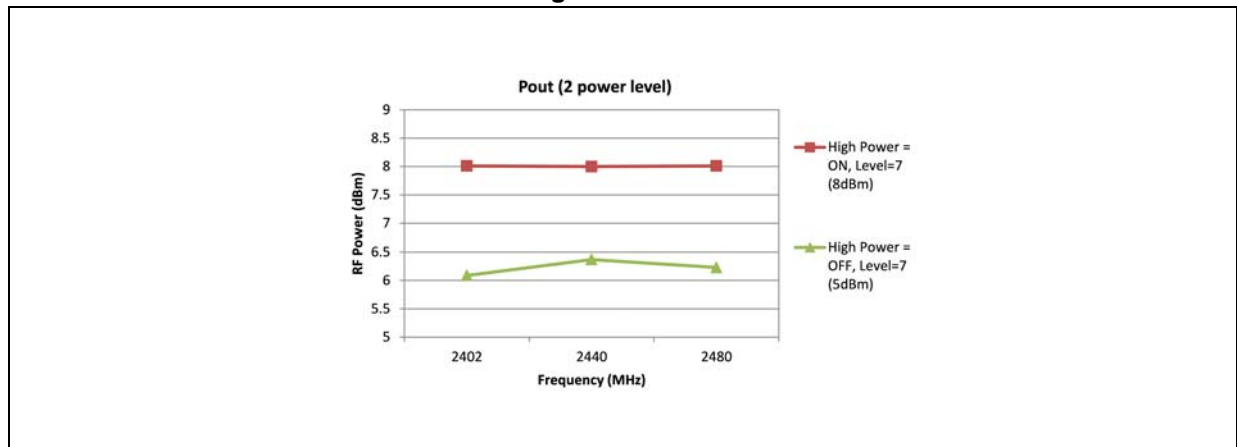

Figure 16. Pout



3 BALF-NRG-01D3 with WLCSP type BlueNRG

Figure 17. Recommended balun land pattern (WLCSP)

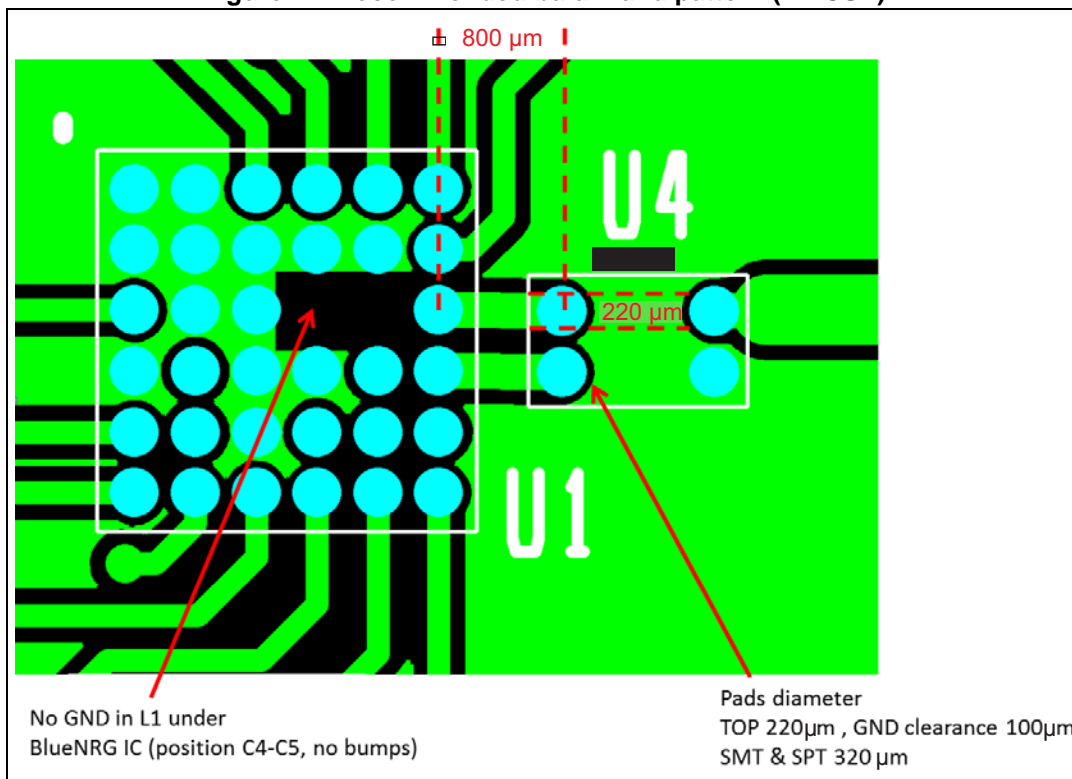
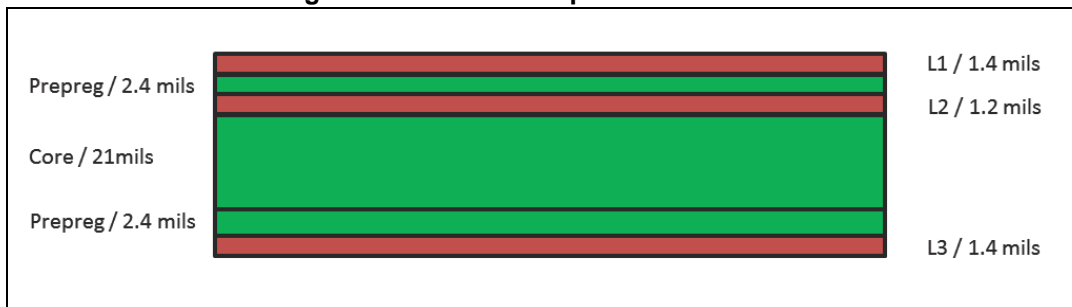

Figure 18. PCB stack-up recommendation



3.1 BALF-NRG-01D3 measurements on WLCSP EVB

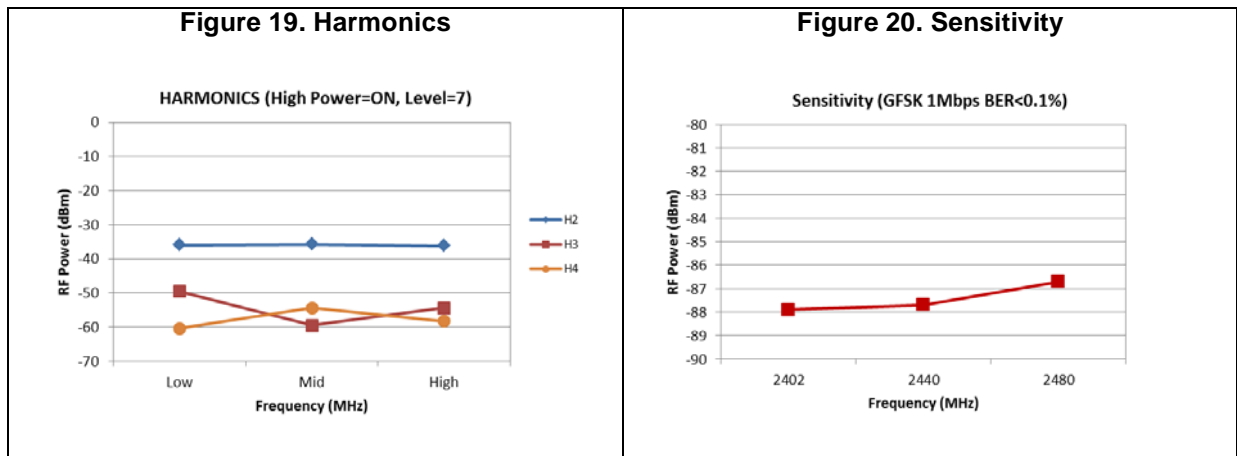
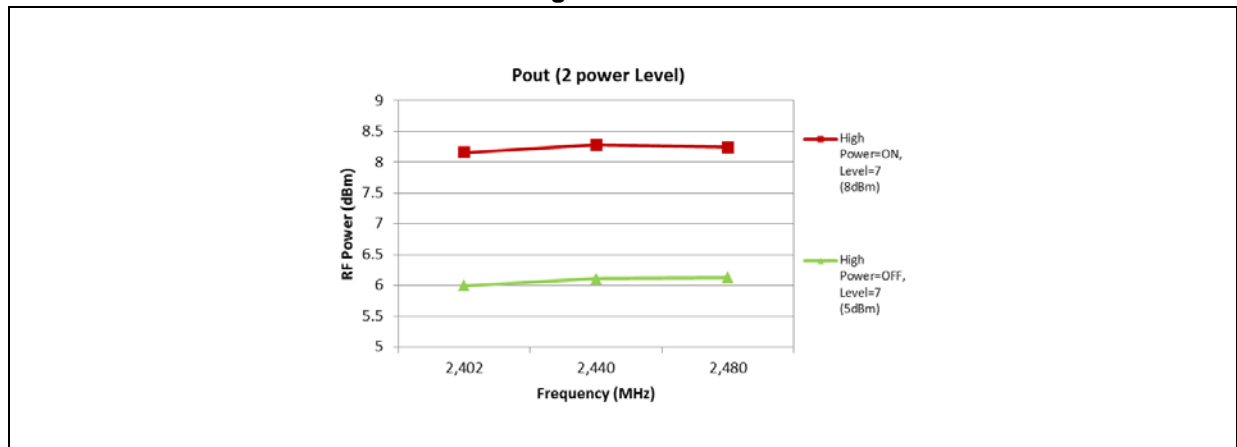

Figure 21. Pout



4 Package information

- Epoxy meets UL94, V0
- Lead-free package

In order to meet environmental requirements, ST offers these devices in different grades of ECOPACK[®] packages, depending on their level of environmental compliance. ECOPACK[®] specifications, grade definitions and product status are available at: www.st.com. ECOPACK[®] is an ST trademark.

4.1 Flip-Chip package information

Figure 22. Flip-Chip package outline

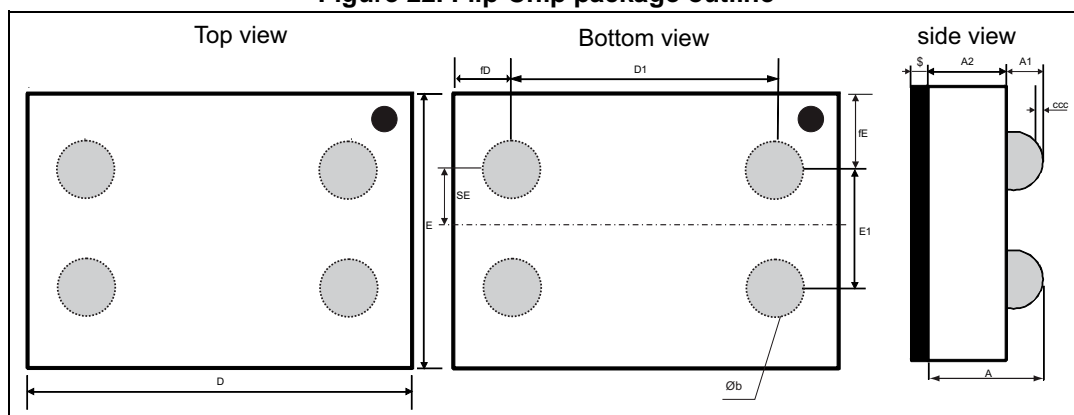

Table 4. Flip-Chip package mechanical data

Dim.	mm		
	Min.	Typ.	Max.
A	0.580	0.630	0.680
A1	0.180	0.205	0.230
A2	0.380	0.40	0.420
b	0.230	0.255	0.280
D	1.375	1.40	1.425
D1	0.99	1	1.01
E	0.825	0.85	0.875
E1	0.39	0.4	0.41
SE		0.2	
fD	0.17	0.2	0.23
fE	0.195	0.225	0.255
ccc			0.05
\$		0.025	

Figure 23. Footprint - 3 mils stencil - non solder mask defined

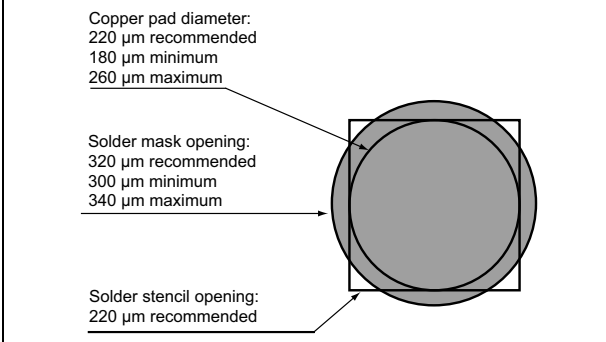

Figure 24. Footprint - 3 mils stencil - solder mask defined

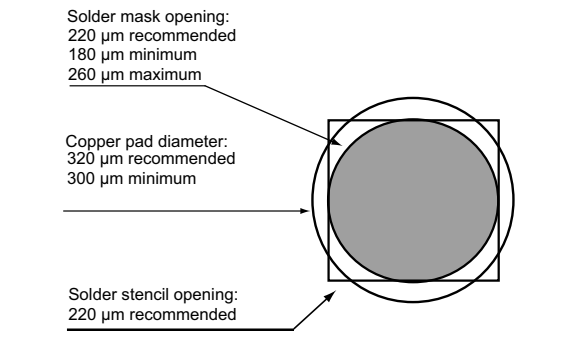

Figure 25. Footprint - 5 mils stencil - non solder mask defined

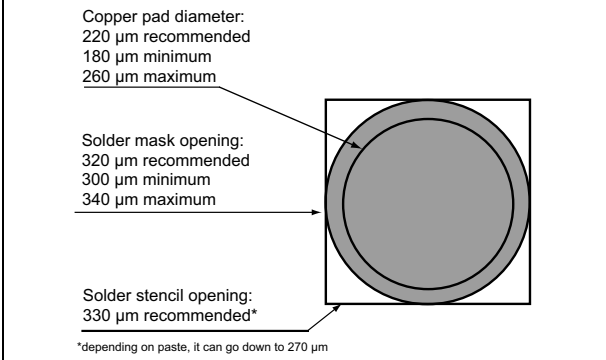
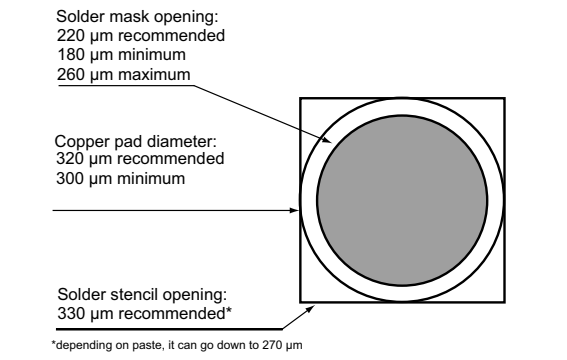

Figure 26. Footprint - 5 mils stencil - solder mask defined



4.2 Packing information

Figure 27. Ball assignment

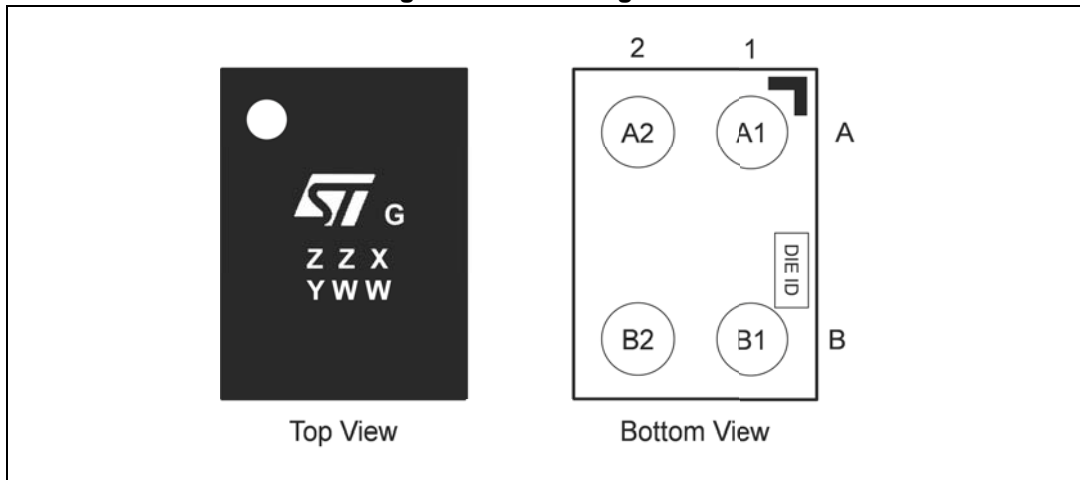
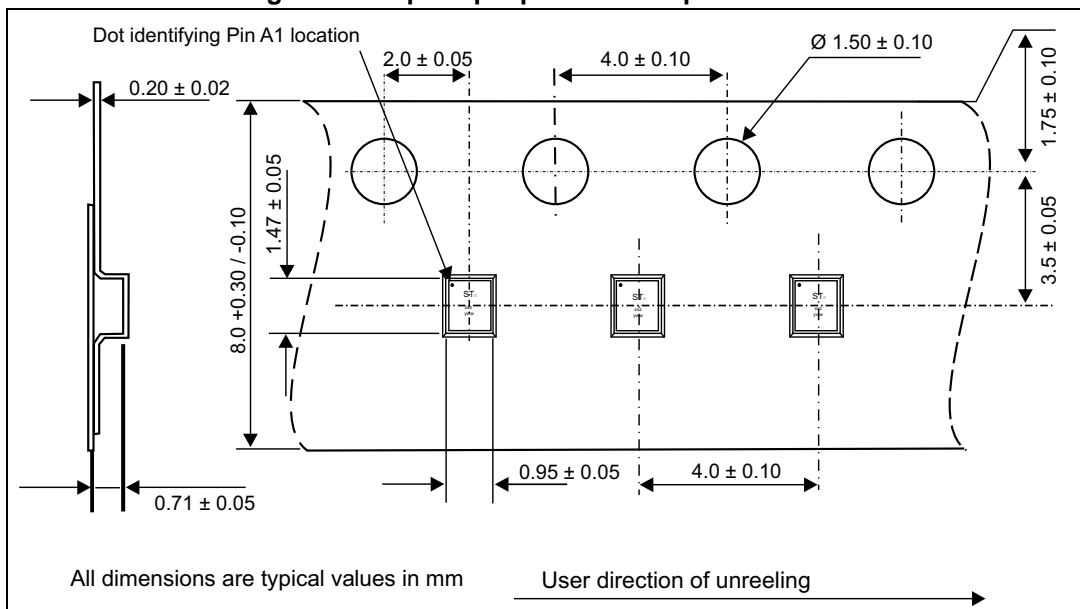

Table 5. Ball assignment details

Ball	Name	Description
A1	ANT	Antenna connection
A2	GND	Ground
B1	Rx_P	Balun receive positive output
B2	RX_N	Balun receive negative output

Figure 28. Flip Chip tape and reel specifications



Note: More information is available in the STMicroelectronics application notes: AN2348 Flip-Chip: “Package description and recommendations for use”

5 Ordering information

Table 6. Ordering information

Order code	Marking	Weight	Base Qty	Delivery mode
BALF-NRG-01D3	SV	1.35 mg	5000	Tape and reel (7")

6 Revision history

Table 7. Document revision history

Date	Revision	Changes
17-Jun-2014	1	Initial release
17-Jul-2014	2	Updated Figure 13, Figure 17, Figure 22 and package view on cover page. Corrected typo error on Table 2.
18-Aug-2014	3	Updated title and description in cover page.
29-Sep-2015	4	Updated Figure 22 . Added Figure 25 and Figure 26 . Reformatted to current standards.

IMPORTANT NOTICE – PLEASE READ CAREFULLY

STMicroelectronics NV and its subsidiaries (“ST”) reserve the right to make changes, corrections, enhancements, modifications, and improvements to ST products and/or to this document at any time without notice. Purchasers should obtain the latest relevant information on ST products before placing orders. ST products are sold pursuant to ST’s terms and conditions of sale in place at the time of order acknowledgement.

Purchasers are solely responsible for the choice, selection, and use of ST products and ST assumes no liability for application assistance or the design of Purchasers’ products.

No license, express or implied, to any intellectual property right is granted by ST herein.

Resale of ST products with provisions different from the information set forth herein shall void any warranty granted by ST for such product.

ST and the ST logo are trademarks of ST. All other product or service names are the property of their respective owners.

Information in this document supersedes and replaces information previously supplied in any prior versions of this document.

© 2015 STMicroelectronics – All rights reserved